

PRINCE *of* PEACE

CATHOLIC CHURCH

621 Cedar Road
Chesapeake, Virginia 23322

Tel 757-547-0356

(Answering service on call after hours)

Fax 757-436-6477

Father John Bosco Walugembe, *Pastor*
Sister Dolores Sabisky, IHM, *Pastoral Associate*

Parish Email

pop.office@popparish.org

Parish Website

www.popparish.org

Mass Live Stream

www.facebook.com/popchurchchesapeake/
or [youtube.com](https://www.youtube.com)

Diocesan Website

www.richmonddiocese.org

Bulletin Deadline

Tuesdays at noon

Office Hours

Monday-Thursday, 9:00 AM - 4:00 PM
Friday, 9:00 AM - 12:00 PM



MASSES

Saturday	5:00 P.M.	
Sunday	9:00 A.M.	
	11:00 A.M.	<i>Livestreamed</i>
Tuesday-Friday	9:00 A.M.	

RECONCILIATION

Every Saturday at 3:30 P.M.

REGISTER IN THE PARISH

Welcome! To join the parish,
please contact our office at
pop.office@popparish.org.

STAFF

DIRECTOR OF RELIGIOUS EDUCATION:

Mrs. Melody Smith

YOUTH/YOUNG ADULT COORDINATOR:

Mrs. Kelly Bruno

MUSIC MINISTER:

BOOKKEEPER:

Mrs. Pam Lerach

SECRETARY:

ADMINISTRATIVE ASSISTANCE:

Mrs. Tanya Cole

FACILITIES MAINTENANCE COORDINATOR:

Mr. John Leonard

CHAIRPERSONS

Parish Council:

Mike Corrigan.....775-7696

Finance Council:

Barb Blumfelder548-1951

MINISTRY CHAIRPERSONS

Christian Formation:

Heather Thomas.....619-8776

Community Life:

Sheila Gargiulo.....716-244-2031

Evangelization/Peace & Justice:

Mary Riley560-6444

Liturgy:

Debbie Tucker.....436-0456

Stewardship:

Alan Cole.....802-5820

CALENDAR OF EVENTS THIS WEEK: JUNE 11-18, 2023

SUNDAY, JUNE 11

9:00 a.m. Mass

11:00 a.m. Mass (also livestreamed)

1:00 p.m. Baptism Preparation Session (virtual)

MONDAY, JUNE 12

9:00-10:00 a.m. Drop off groceries at Food Pantry

TUESDAY, JUNE 13

No Mass

WEDNESDAY, JUNE 14

9:00 a.m. Mass followed by praying the Holy Rosary

10:00-11:30 a.m. Food Pantry

THURSDAY, JUNE 15

9:00 a.m. Mass

FRIDAY, JUNE 16

9:00 a.m. Mass followed by praying the Holy Rosary

SATURDAY, JUNE 17

3:30 p.m. Reconciliation

5:00 p.m. Mass

SUNDAY, JUNE 18

9:00 a.m. Mass

11:00 a.m. Mass (also livestreamed)

ORATIO IMPERATA:

God Our Father, we come to You in our need to ask Your protection against the 2019 N-Coronavirus that has claimed lives and has affected many. We pray for Your grace for the people tasked with studying the nature and cause of this virus and its disease and of stemming the tide of its transmission. Guide the hands and minds of medical experts that they may minister to the sick with competence and compassion, and of those governments and private agencies that must find cure and solution to this epidemic. We pray for those afflicted; may they be restored to health soon. Grant us the grace to work for the good of all and to help those in need. Grant this through Our Lord, Jesus Christ, Your Son, Who lives and reigns with You in the unity of the Holy Spirit, One God, forever and ever.



SPIRITUAL COMMUNION PRAYER by Saint Alphonsus Liguori

My Jesus, I believe that You are present in the Most Holy Sacrament. I love You above all things, and I desire to receive You into my soul. Since I cannot at this moment receive You sacramentally, come at least spiritually into my heart. I embrace You as if You were already there and unite myself wholly to You. Never permit me to be separated from You. Amen.

MASS INTENTIONS

TUESDAY, JUNE 13

No Intentions

WEDNESDAY, JUNE 14

Antonio DiBenedetto †

THURSDAY, JUNE 15

Victor Hrudowsky Jr. †

FRIDAY, JUNE 16

Gene DePascale
Mass Intention

SATURDAY, JUNE 17

Leigh Armstrong †

SUNDAY, JUNE 18

9:00 a.m. Chester Sabisky †
11:00 a.m. For the Parishioners

† denotes deceased

*In order to keep with Canon Law, as of March 13, 2019, there will be only one Mass Intention offered per Mass. Mass Intentions for the repose of the soul and Special Intentions can be made at least two weeks before the requested day. The Parish Office will not be able to schedule Mass Intentions on the same week of the requested day. Thank you for understanding.



2023 Annual Appeal:

Once again, this year, Prince of Peace is participating in the Annual Diocesan Appeal. The Appeal is a yearly opportunity to support the next generation, provide for those in need and build up our Catholic communities. Each gift that is contributed to the Appeal makes a real difference because the gifts enable our Diocese to deliver needed ministries and services such as health insurance and long-term care for our retired priests, tuition for our future priests to attend the seminary and heating and grocery assistance to families through the Fuel and Hunger Fund, from which we again this year received a grant to assist our local community. In addition, all parishes receive back a portion of their funds to be used for local priorities.

Scan the QR code to donate to the 2023 Annual Diocesan Appeal or visit <https://richmondcatholicfoundation.org/appeal-2/>.

MASS COUNTS FOR LAST WEEKEND

Saturday, 5:00 p.m.	189
Sunday, 9:00 a.m.	212
Sunday, 11:00 a.m.	332
TOTAL	733

PRINCE OF PEACE POLICY:

Anyone requesting a Godparent sponsor letter, a Confirmation sponsor letter, or a letter verifying church membership, must be a registered member of the Parish a minimum of six months.

ASSISTANCE FOR 65+ OR AT-RISK PARISHIONERS:

During this time where you may be self-quarantining due to your age or because you are high risk, if you need assistance with grocery shopping or other high importance errands, please give our Parish Office a call at 757-547-0356. We will contact a parish volunteer to call you to assist you with your needs.

THIS WEEK'S SCRIPTURE QUOTE FOR MEDITATION

June 11, 2023: The Most Holy Body and Blood of Christ
 John 6:51: *"I am the living bread that came down from heaven; whoever eats this bread will live forever; and the bread that I will give is my flesh for the life of the world."*

READINGS FOR NEXT WEEK

June 18, 2023: Eleventh Sunday in Ordinary Time

1st Reading: Exodus 19:2-6a

2nd Reading: Romans 5:6-11

Gospel: Matthew 9:36-10:8

ALTAR SERVER MINISTRY

Prince of Peace is beginning an Altar Server Ministry. Youth – girls and boys – who are in Middle School-High School are invited to be part of this ministry. Parents of youth interested in the Altar Server Ministry are asked to contact Sister Dolores at the Parish Office.

RECONCILIATION TIME CHANGE

In order to allow more opportunity for those wishing Confession, Father John Bosco will begin hearing Confessions at 3:30 p.m. Saturday ongoing. This change is effective immediately.

MASS INTENTIONS

Mass Intentions are available to offer in the Parish Office. There is a limit of five Intentions per person and the requested donation is \$10.00 each.

PRINCE OF PEACE CATHOLIC CHURCH, CHESAPEAKE: OPEN POSITIONS

Music Minister – The position is a full-time music minister with hours approximately 35 hours per week devoted to the liturgical music of the parish. The position entails playing at all weekend and Holy Day Masses, as well as weddings and funerals. The position includes planning and directing a comprehensive musical program for the parish, with both an adult and youth choir. The individual would also be responsible for planning, rehearsing and coordinating music for sacramental and faith formation events. Qualified candidates must be a practicing Roman Catholic with an undergraduate degree (B.S. or B.A.), proficient in both piano and organ with a reasonable competence of Catholic theology. Compensation will be based on the guidelines for the Diocese of Richmond. Interested candidates must submit a Diocesan application and résumé to jwalugembe@richmonddiocese.org or mail to Prince of Peace Catholic Church, Attention: Fr. John Bosco Walugembe, 621 Cedar Road, Chesapeake, VA 23322

Parish Secretary – The ministry includes greeting parishioners and visitors in person and on the phone; maintaining census data using Parishsoft; distributing mail; creating weekly bulletin and maintaining parish calendar; providing assistance to the various ministries and performing other related duties as requested by the Pastor. Minimum education requirement of a high school diploma; work experience in secretarial/administrative assistance. Some college preferred. This is a full-time but non-exempt position. Must possess computer skills and be proficient with Microsoft Office products. Candidate must be a practicing/participating Catholic in good standing with the church; understand and adhere to the policies as stated in the Diocese Guidelines and Procedures. Those interested in this position should complete the Diocese of Richmond application at <https://richmonddiocese.org/office-of-human-resources/>, a cover letter, and résumé. Must be able to pass a background check. Send all required documents with references to Father John Bosco Walugembe at jwalugembe@richmonddiocese.org. Please, no faxes.

MUSIC MINISTRY:

Do you have a song in your heart? Do you find yourself humming from time to time? Well, God appreciates your gifts and so do we! Prince of Peace Music Ministry is in need of singers and instrumentalists who can share their gifts with our congregation. Beginners are needed, too! Whether you are new to music or have been doing this for a long time, there is a place for you to play or sing in the choir. Send inquiry to pop.office@popparish.org or see Melody or Sister Dolores.

VOLUNTEERS NEEDED

We are looking for volunteers for our coffee and snacks after weekend Masses. This volunteer opportunity requires limited time involvement. Please consider participating in this ministry. Contact Ellen Green at egreen1016@icloud.com or 757-646-2117.

AUDIO/VISUAL VOLUNTEERS WANTED:

Are you good with computers or just want to try something new? If you are 16 years or older, come and join our ministry. There's no experience necessary, because we will train and place you in a team of two people during livestreaming. Our livestreaming ministry also needs volunteers to just enter the Scripture verses and load the songs into the system whenever is convenient for them. Everyone at all skill levels is needed. Contact pop.office@popparish.org to find out more!

DIRECTOR OF CAMPUS MINISTRY NEEDED

The Catholic Diocese of Richmond is seeking a Director of Campus Ministry to serve the Catholic Campus Ministry communities of Virginia Military Institute and Washington and Lee University in Lexington, VA. Virginia Military Institute is a public institution in the military tradition with an enrollment of 1,700 undergraduate cadets. Washington and Lee University is a private, liberal arts school with an enrollment of 2,175. The Director of Campus Ministry is responsible for the development, implementation, and oversight of a comprehensive campus ministry program for the students of Virginia Military Institute and Washington and Lee University. These responsibilities include developing student leaders, pastorally responding to student needs, and overseeing student programs and activities. Additionally, the Director oversees financial accounts, serves as the liaison between the campus ministry and the local Catholic parish, furthers development efforts, and builds interfaith relationships among the other campus ministries.

Qualifications: Must be a practicing Catholic in good standing. A minimum of a bachelor's degree is required with a master's degree preferred (in a relevant field). Three to five years of prior experience in pastoral work, preferably campus ministry. This is a full-time exempt position on a salary basis. The salary is commensurate with experience and diocesan pay scale. Interested candidates should submit a cover letter, résumé and full application at <https://bit.ly/3N4tPwL>. For any questions or additional information, contact Kelly Shumate, HR Generalist/Recruiter at jobs@richmonddiocese.org.

ULTRASOUND TECHNICIANS NEEDED

The Hope 4 Life Medical Mobile Pregnancy Resource Center is hiring **ultrasound technicians to work flexible part-time hours at a competitive salary**. Since its founding in 2014, we have helped mothers to welcome 1,047 babies into the world by providing medical, moral, and material support to expectant moms outside of the three abortion "clinics" in our area. Offering free pregnancy tests, ultrasounds and baby supplies, Hope 4 Life needs more volunteers to assist families in the community as sidewalk advocates and administrative staff. Please call Louantha Kerr at 757-810-1653 for more information about this special ministry or send an email to ourhope4life@gmail.com.

ASSISTANT EDITOR NEEDED

Are you a writer who loves to tell a good story? Is working with words your passion? Then become part of our team! The Catholic Diocese of Richmond's Office of Communications is seeking a talented, experienced, motivated assistant editor to join our small, creative, and award-winning, multimedia team. We are looking for someone with drive and focus to cover Catholic news and write inspirational faith stories found within the multiple communities we serve. Additionally, we want someone who can balance the importance of print and digital platforms for our diocesan newspaper, *The Catholic Virginian* (CV). If interested, please see the full ad and how to apply at <http://bit.ly/3WVJfGD>.

FORMED.ORG:

Prince of Peace offers a wide variety of Catholic movies, educational programs, seminars, books, and spiritual exercises for all POP families and adults at no cost to them. Here is how to get signed up!

1. Go to www.formed.org.
2. Click on the blue "Sign up as a Parishioner" button.
3. Enter: "Prince of Peace, 621 Cedar Road, Chesapeake, VA"
4. Enter your Name and Email.

SACRAMENTS

BAPTISMS: *Baptismal Preparation*

In preparation to celebrate the Sacrament of Baptism with an infant, the parents are asked to attend a Baptismal Preparation Session at Prince of Peace. Sessions are being held by Zoom until further notice. The sessions will begin at 1:00 p.m. and last 45 minutes to an hour. The next sessions scheduled at Prince of Peace:

- **Sunday, June 11, 2023**
- **Sunday, July 16, 2023**
- **Sunday, August 20, 2023**

Parents are asked to register for the sessions by visiting our parish website at popparish.org. Go to the *Sacrament* tab and scroll down to *Baptisms*.

Anyone with questions, please contact Sister Dolores at the Parish Office.

ADULT CONFIRMATION: Any adult Catholic who has never been confirmed; sessions are held throughout the year. For more information, please call Sister Dolores at the Parish Office or email her at Sister.Dolores@popparish.org.

RCIA: *Thinking of joining the Catholic Church???*

Prince of Peace parish community offers "Rite of Christian Initiation of Adults" (RCIA) process for those adults seeking to learn more about and join the Catholic Christian Faith. RCIA is for those who are not yet baptized and also for Christians of other denominations who choose to seek full Communion with the Catholic Church. If you are interested or know someone who might be interested in learning more about the RCIA journey, please contact Sister Dolores at the Parish Office at 547-0356, or email Sister.Dolores@popparish.org.

VIRTUS:

All Catechists, Assistants, VYMs, people in leadership roles, and those serving minors or vulnerable adults are required to register for and attend a one-time class, VIRTUS Protecting God's Children. Registration for the class will initiate the Safe Environment Screening which is required every five years. Please register at <https://www.virtusonline.org/>.



REGISTER NOW FOR THE 2023/2024 CONFIRMATION MEETING

If your son/daughter will be in 10th grade in September 2023, has celebrated the Sacraments of Baptism and Eucharist, and wishes to receive the Sacrament of Confirmation in spring 2024, you and your teenager are invited to attend a mandatory Confirmation Information Meeting on Sunday, July 30 at 7:00 p.m. Please take a moment to register your teen. This is the last scheduled meeting before Confirmation classes begin. You may also register from our website at <https://popparish.org/sacraments/confirmation/>.



LUMEN CHRISTI
LEGACY SOCIETY

We celebrate the **Feast of Corpus Christi on June 11**, the presence of the Most Holy Body (Corpus) of Jesus Christ in the Eucharist. We become one body, one community. We support each other to become people of courage, compassion and commitment in our faith and being a positive difference in the world. This is the perfect time for you to celebrate our most precious gift with giving an everlasting gift to the Prince of Peace community. Please view [A Guide to Legacy Giving Brochure](#) on the Prince of Peace website at www.popparish.org. Go to **Support Your Parish**, then to **Legacy Giving**. Contact Nick Vacca at nbv8080@outlook.com for additional information, or contact him at the Parish Office at 757-547-0356. If you have already included Prince of Peace in your Will, "Welcome as a Lumen Christi Society Member."



LAUNCH YOUR ROCKETS INTO AN OUT-OF-THIS WORLD ADVENTURE WITH STELLAR VBS 2023!

This summer, all children, teens and adults can attend Stellar Vacation Bible School! **Stellar VBS 2023** takes place June 26-29th from 9:00 a.m.-noon and June 30th 9:00 a.m.-1:00 p.m.! Make your mark in God's beautiful universe!

At **Stellar VBS 2023**, all help and skill levels are needed! VBS participants, group guides, and station helpers are needed June 26th-29th, 8:30 a.m.-noon, and June 30th, 8:30 a.m.-1:00 p.m. Volunteer hours apply! Would you like to make it your family project to build a space ship, or a robot, or a moon walk scene! Setup is June 19th-24th from 9:00 a.m.-noon and June 25th, noon-3:00 p.m. Whether you are an adult or a teen, help us make VBS 2023 just as wonderful as last year by contacting Melody.Smith@popparish.org to tell us about your special gifts you have to share!

Children's Worship Bulletin™



Ages 3+

June 11, 2023 • Deuteronomy 8:1-16

Remember God During Good Times

Moses said, "Remember how God led you in the desert."

Find the way.

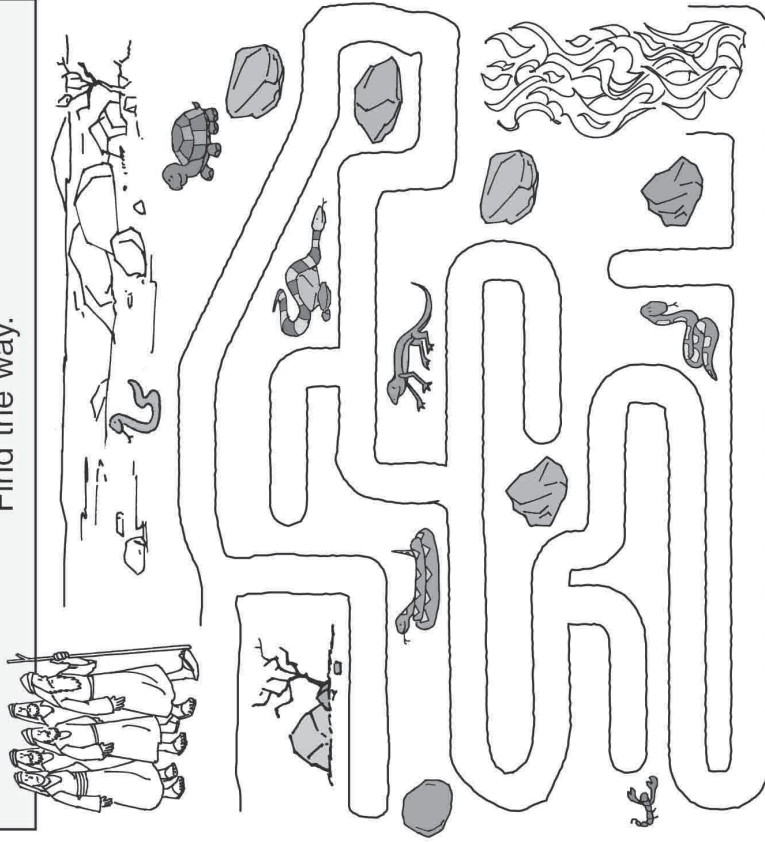

Praise the Lord for all He has given you.

Circle the things you are thankful for.

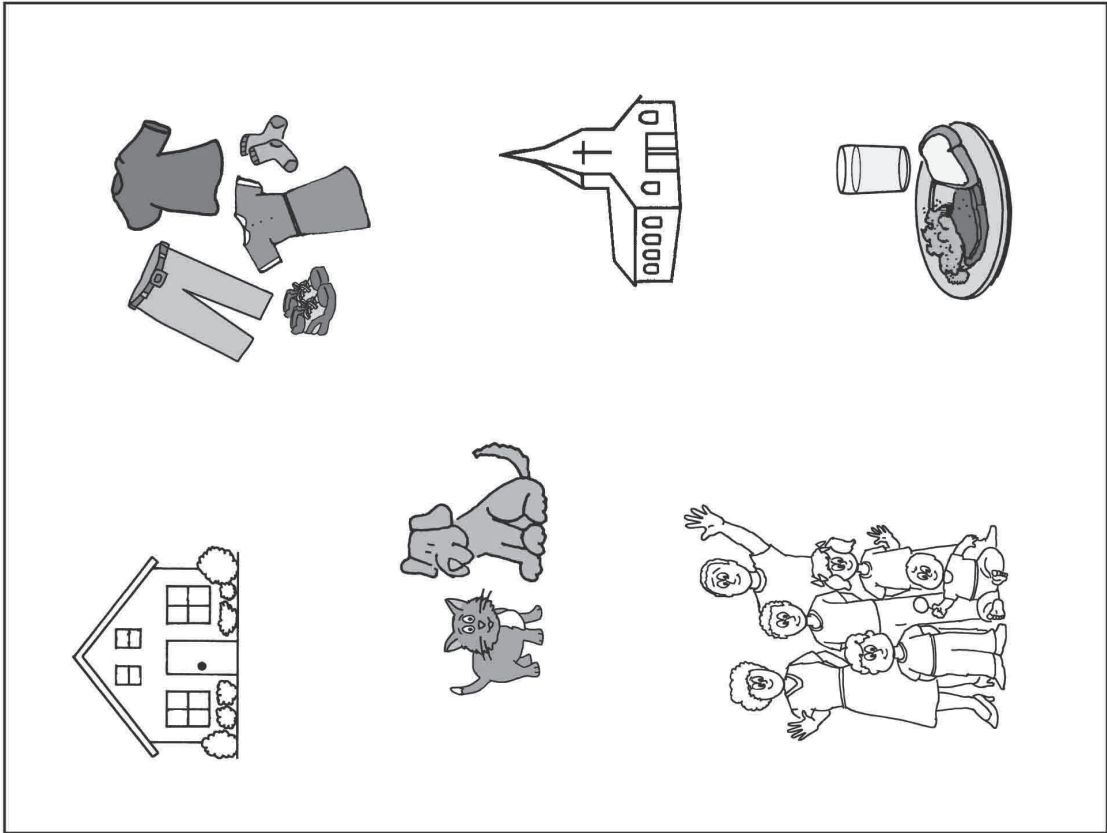

The Lord brought you from the desert into a good land flowing with springs of water.

Circle 5 differences in the 2nd picture.

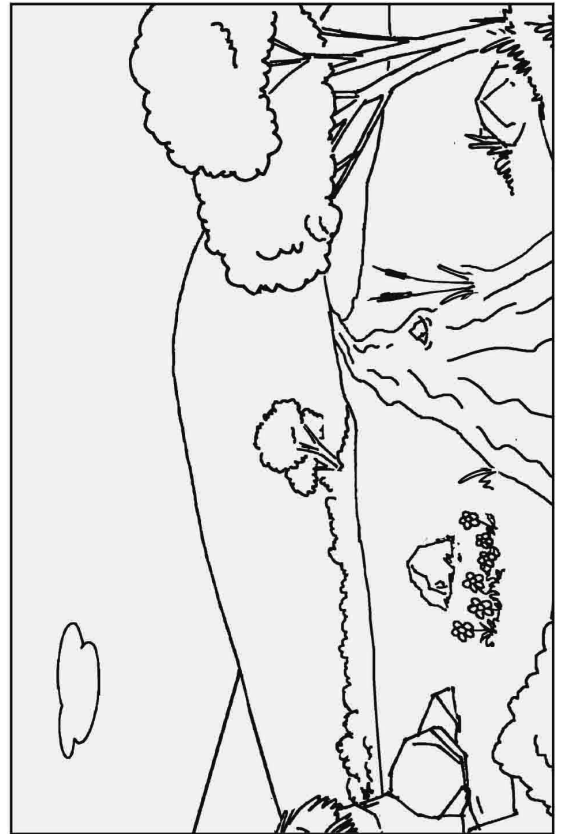
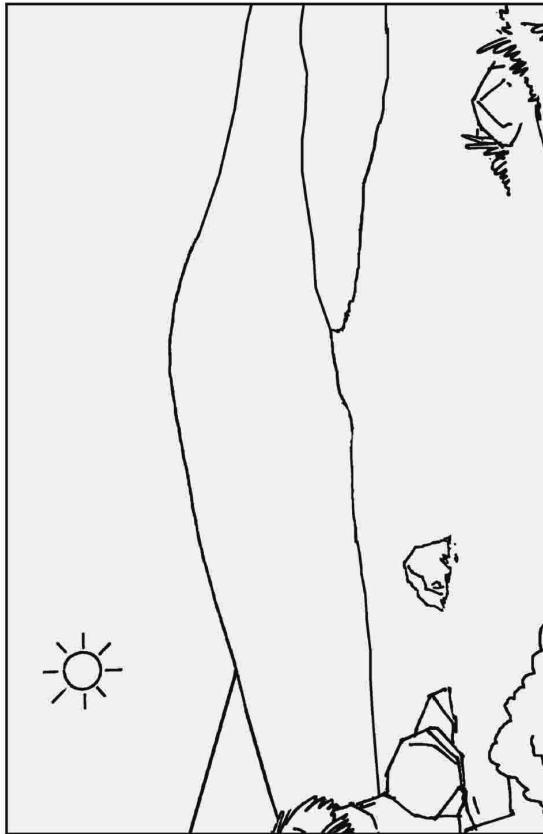

Do not forget God when times are good.

Match the pictures.

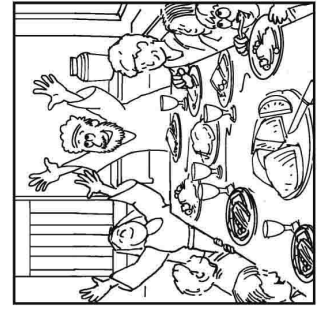
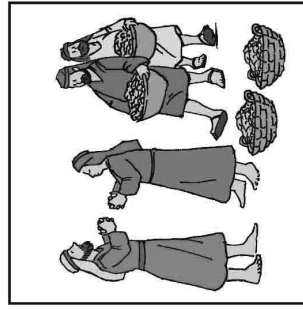
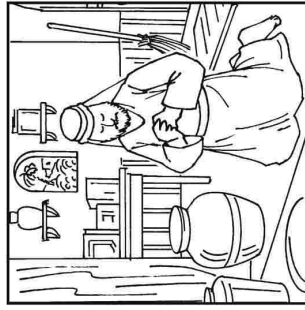
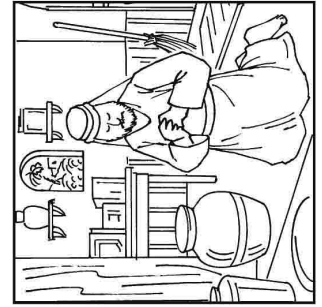
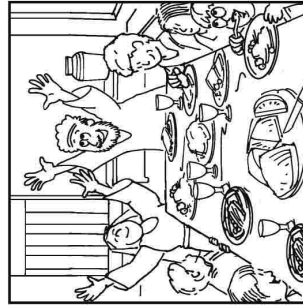
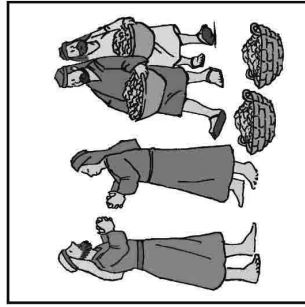

YOUNG ADULT



THEOLOGY ON TAP

The goal of Theology on Tap in the Diocese of Richmond is to provide a place for young adults (roughly ages 21-35) to gather, delve into a Catholic topic, and connect with other young adults in the area. All young adults, whether single or married, are welcome!

Date: Last Thursday of the month

Location: Locations rotate every month, contact Chloe for more information

Time: 7:00-9:00 p.m.

Contact: Chloe Barnes at oliviafreeman804@outlook.com.



THEOLOGY ON TAP

FAITH & FITNESS: THE BODY OF CHRIST

VIBRANT SHORES BREWING CO.
@BACK DECK BEER GARDEN
(WEATHER PERMITTING)
505 18TH ST. VB, VA 23452

FREE PARKING PASS AVAILABLE
ON SITE. PLEASE PARK IN THE
SSI LOT JUST ON THE CORNER &
PLACE DASH ON YOUR DASH

FOOD TRUCK WILL BE ON SITE
FOR A MEAL

JUNE 29TH
7-9 PM
\$3 COVER



GUEST SPEAKER:
JUDY MINGIN
OWNER/HEAD COACH OMNIA
FITNESS COACHING

THANK YOU!

We had a great turnout at Sunday's **Spring Raffle & Ice Cream Social**. Because of your kindness and generosity, we were able to raise \$17,731.00 to support outreach ministries here in our community, helping folks that are experiencing hunger and homelessness. Congratulations to our winners who took home \$500.00 cash, a 50" Fire TV, and lots of gift cards. A special thanks to all of the volunteers and staff who made it happen. Stewardship is alive and well at Prince of Peace! God bless.

PEACE AND JUSTICE:

We strive to live the love of Christ
by sharing it with those in our community.



HELPING OUR HOMELESS CHESAPEAKE NEIGHBORS:

We have several ongoing programs to support our homeless neighbors within Prince of Peace and we also partner with many other churches in the area. We have an Amazon Wishlist of what we call "shelf stable" items; this is a quick and easy way to buy items we use every week and would be a wonderful way to support this ministry if you don't have time to make sandwiches, etc... it is as easy as going to the link via the QR code, ordering and having them sent to POP – Homeless Meals, the address will be available for you to choose once you go to checkout!! If you have any questions at all, please just email me at cooeybrooks@cox.net. Thank you so much!!



FOOD PANTRY

MONTHLY FOOD COLLECTION DATES...

Saturday and Sunday, July 1/2, August 5/6
(Mark your calendar. Drop off food bags

before each Mass in the Commons.)

FOOD PANTRY HOURS...

Mondays, 9:00-10:00 a.m. – Drop off food... Pantry Volunteers are available to help with your bags or boxes.

Wednesdays, 10:00-11:30 a.m. – (Pick up & Drop off food)
Food bags can be dropped off at the food pantry located in the back of the church. Do not leave food outside of the doors. Parishioners who need assistance, contact the office for a date and time to pick up food or pick up food on Wednesdays between 10:00-11:30 a.m.

SOME SHOPPING ITEMS NEEDED, PLEASE CONSIDER...

Canned Fruit, Jell-O, Hamburger Helper, Jelly, Canned Soup, Pork & Beans, Peanut Butter

If you would rather have the pantry do the shopping, consider a financial contribution. Financial gifts can be made in cash, check, and by going to popparish.org and submit through E-giving. If you are writing a check, in memo, write "Food Pantry." Thank you and God bless.

PARISH COMMUNITY LIFE



GRAND GROUP NEWS

Grand Group takes the summer off. Stay tuned for upcoming events and meetings. Contact Judy at judithflorance@cox.net or Joan at stanjam22@aol.com with any questions.

FOOTSTEPS OF ST. PAUL IN TURKEY & GREECE, VIRGIN MARY'S HOUSE IN EPHEBUS

There is still time to join us as we travel to follow in the Footsteps of St. Paul. **September 26-October 8, 2023**. This tour will take us to Istanbul, Troy, Pergamum, Ephesus, St. John Monastery, Smyrna, Aegean Cruise, Rhodes, Patmos, Crete, Santorini, and Athens. Daily Mass with Fr. Romeo Jazmin. For registration, please contact Luis Anacta at 757-401-3817 or Jocelyn Anacta at 757-729-5685 or louieanacta@gmail.com.

SACRED HEART REVIVAL

Do you want more peace in your family, blessings on your undertakings, and a more perfect faith life? Jesus is standing at the door and knocking. Open the door for Him! Join our nationwide campaign to invite the Sacred Heart of Jesus into your home, classroom, or business. Visit www.SacredHeartRevival.com for more information on the graces of the Sacred Heart and sign up today.



Summer Fun For the whole family Ocean Breeze Waterpark

June 21 9:30am-3:30pm

Price: \$15.00 per teen/child
\$24.00 per adult

Register by June 15th at:

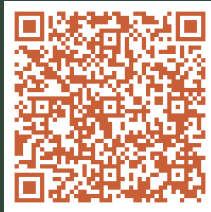

For any question contact
Melody at melody.smith@popparish.com
Kelly at kelly.bruno@popparish.com



PARISH COUNCIL

Parishioners are asked to please consider volunteering to sit on our parish council. This is an opportunity for parishioners, active in our ministries, to provide advice and support to our pastor. The council meets once a month. There are five vacancies available. Council members serve a three-year term. If you are interested in serving or would like to suggest someone, please write a letter expressing your interest or a letter suggesting an individual and send it to Father John Bosco.

WORLDWIDE MARRIAGE ENCOUNTER EXPERIENCES

Does your Marriage need a boost? A Worldwide Marriage Encounter Experience will help you enjoy life with a new closeness to each other and God. You don't need it - you DESERVE a Marriage Encounter Experience! For more information or to register, go to WWME.org, click "Apply" and search for "Virginia" or your desired location. Feel free to contact Mark and Cathy Stangler at 703-378-4150 or mstang1987@aol.com with any questions.

Upcoming dates:

September 22-24, 2023 -

Crowne Plaza Hotel, Herndon, VA

November 17-19, 2023 -

Holiday Inn, Virginia Beach, VA



KNIGHTS OF COLUMBUS 8240:

Attention, Catholic Men! Have you ever thought of joining the Knights of Columbus? The Knights of Columbus is the largest fraternal Catholic organization in the world. Men age 18 and over, who are practicing Catholics, are strongly encouraged to join for a variety of reasons. All Knights strive to be Catholic gentlemen, to learn more about their faith, and are dedicated to putting their faith in action in support of their church, family, community, and, yes, charities that help benefit children, the elderly, the handicapped, and the homeless. Prince of Peace Knights of Columbus Council 8240 has existed for over 35 years. Working together in unity and fraternity, the Brothers have helped countless families, individuals, church programs, and benefits over the years. We make a difference! Come join us. For more information, please contact Grand Knight Joe Branco at joebranco@cox.net or call 757-560-3073.



THE MOVEMENT OF CURSILLOS IN CHRISTIANITY
DIOCESE OF RICHMOND

Do you want to grow in your faith and have a more intimate relationship with Jesus?

We invite you to participate in the:
Second Cursillo in Spanish for Women
June 22 to 25, 2023

Second Cursillo in Spanish for Men
August 17 to 20, 2023

St. Clare of Assisi Retreat Center
620 Buckroe Ave, Hampton, VA 23664



For more information contact
Linda Estepa– Spanish Coordinator
757-374-2493 * cursillistador@protonmail.com

Make a friend, Be a friend and Bring your friend to Christ!

**UPCOMING
SECOND COLLECTIONS:**

Peter's Pence	June 10/11, 2023
POP Capital Improvement	June 17/18, 2023
POP Capital Improvement	July 15/16, 2023

REMEMBER IN PRAYER these people, and all who are kept from joining us due to their health...

NURSING HOME/ASSISTED LIVING RESIDENTS: Dick DeLong, Joseph Rejuney, Joan Crane, Marie Kuenzer (MC), Susan Ott, Mary Oliver, Elizabeth Farrell and Phyllis Hunt.

CHESAPEAKE HEALTHCARE CENTER:

Clair Saar, Mary Thatcher, Mike Walker, Anna Phillips, Rafaela Martinez, and Elizabeth Bolmarcich.

AT HOME: Bonnie Gallimore, Gene DiPascale, John Heerema, Jr., Doris Moyer, Joseph Evan, Patty and Al Russell, Ada Murphy, Sherri Yewitt, Paul Michael Thomas, and Colleen Richardson.

IN THE HOSPITAL: Let us pray for all those currently in the hospital.

REMEMBER IN PRAYER THOSE WHO HAVE DIED: William Barzano

Our bulletin is printed at no cost to the parish. Our advertisers cover all expenses. We thank them and encourage you to support their businesses.

PLEASE PATRONIZE OUR ADVERTISERS... TO PLACE AN AD, CALL 1-800-292-9020

<p>Fulfill Your Passion to Help Young People – Join Our Team! We're a nonprofit organization that's been improving the lives of children since 1933. Check us out for rewarding career opportunities and generous benefits.</p> <p>barryrobinson.org</p>	<p>The Barry Robinson Center A Behavioral Health System for Youth</p>	<p>Doherty Plumbing Services, LLC Chesapeake 757-842-4221 Paul Doherty dohertyplumbing@gmail.com Licensed & Insured VA# 2705-129749</p>	<p>Beach Tree & Stump Fast, High Quality Service at a Fair Price 757-646-3085 Licensed & Insured Sam Harmon, Owner/Operator, USN Retired</p>	
<p>State Farm Providing Insurance & Financial Services Home Office, Bloomington, Illinois 61710 Andy Saunders, Ins. Agency Inc 825 Battlefield Blvd. S., Chesapeake, VA 23322-6607 Bus: 757-482-3315 Fax: 757-482-0013 andy.saunders.bv37@statefarm.com</p> <p>Like a good neighbor, State Farm is there.</p>	<p>ANDY SAUNDERS AGENT</p>	<p>Fine Furniture & Accessories Residential/Contract Esprit Decor 110 Kegman Rd. W, West Chesapeake HOME FURNISHING 482-5175 • FAX: 482-0961</p>	<p>CHS CATHOLIC HIGH SCHOOL (757) 467-2881 WWW.CHSVB.ORG</p>	<p>Tidewater Termite & Repair, Inc. 133B Tilden Ave., Chesapeake Mike Page • Cell 757-635-0357 Phone: 757-312-8081 Fax: 757-312-8099</p>

POP IN #54383-17-01-01-022

"The Builder's Choice"
CENTRAL PLUMBING & HEATING, INC.
 Plumbing, Heating & Cooling
 757-424-3761 • 757-200-1111
 820 Greenbrier Cir., Ste 6, Ches, VA
 Va Lic. #2701019627A

Faith, Family, & Fraternity

 Council 8240
 Be a part of the largest Catholic Men's Fraternal organization in the world. Join us, call for more information:
757.677.6721
www.kofc8240.org



TO ADVERTISE HERE, EMAIL
JOSEPH@DEEPRINTING.COM



FLOORS UNLIMITED HARDWOOD CERAMIC • CARPET LAMINATES • RESILIENT
1020 Cedar Rd., Chesapeake, VA 23322
757-547-7167 • www.floorsunlimitedva.net

In Compliments of
PLAZA AZTECA

LAWRENCE PHARMACY
Chris and Alison Mercer – Owners and Parishioners

- Home delivery to Portsmouth and Chesapeake
- Compounding Services
- Home Health Care
- Deep Creek Florist
- Grill open for Breakfast, Lunch and Dinner

757-487-3458
www.lawrencepharmacyrx.com

COLDWELL BANKER NOW

TOM SEDDON
 636 Cedar Road, Chesapeake, VA 23322
 757.410.5411

A Lasting Impression Florist

 1020 B Cedar Rd, Chesapeake, VA 23322

757-456-5018
marian-manor.com
 5345 Marian Lane
 Virginia Beach, VA 23462
 Sponsored by the Catholic Diocese of Richmond.

757-495-4211
ourladyperpetualhelp.com
 4560 Princess Anne Rd.
 Virginia Beach, VA 23462
 Our Lady of Perpetual Help
 Memory Care
 Extensive Assisted Living
 Nursing Care

"Empowering leaders one faith-filled day at a time."
 Kindergarten Prep (ages 3 & 4)-8th Grade
Call 757-420-2455
for a private tour
www.smsvb.net

ALTMAYER FUNERAL HOMES & CREMATORY
 Family owned and operated since 1917
www.altmeyer.com
Serving the entire Hampton Roads area

Southside Chapel 5033 Rouse Dr., Virginia Beach 757-422-4000	Oceanfront Chapel 1801 Baltic Ave., Virginia Beach 757-428-1112	Chesapeake Chapel 929 S. Battlefield Blvd., Chesapeake 757-482-3311
---	--	--

 1225 Cedar Rd.
 Chesapeake, VA 23322
757.312.9111
 YNOTITALIAN.COM

REVERSIBLE

T: 757-425-8723

FAMILY FLOORING
 CARPET, VINYL, CERAMIC, HARDWOOD

Jeff Jechura
 757-548-4545
 300 N. Battlefield Blvd.



Paneling Factory Inc.
 Specializing in All Wood Cabinets, Countertops and Floor Coverings.
 5950 Poplar Hall Drive, Norfolk
757-461-1454
 fax: 757-466-0296
panelingfactoryinc.com

Vincent & Jessica Chan
 Parishioners of
 St. Stephen Martyr

Hanaki Sushi
 237 Hanbury Rd. E, Ste. 11, Chesapeake
 757-482-0043 Fax: 757-482-0047
hanakisushi.com
BRING BULLETIN OR AD TO SAVE 5% ON TOTAL CHECK

OMAN FUNERAL HOME & CREMATORY
"Chesapeake's Only Crematory"
757-547-5184

H.D. OLIVER CHESAPEAKE CHAPEL 548-2200 LASKIN ROAD CHAPEL 428-7880
FUNERAL APARTMENTS NORFOLK CHAPEL 622-7353
 Serving the Catholics of Tidewater since 1865
Martin V. Oliver, Owner **Michael J. Leonard, Parishioner**

Catholic Funeral & Cemetery Services
Rev. Mr. Edward J. Handel
Director of Cemeteries
 3686 Ironbound Road, Williamsburg, VA 23185
ehandel@richmonddiocese.org

 Living Our Mission **(757) 229-0851**

Hatcher & Frey ORTHODONTICS
Delivering five star smiles for over 20 years
 GREAT BRIDGE | NORFOLK | WESTERN BRANCH
 757.488.6080 | www.smile-365.com

THE VERO
 AT CHESAPEAKE
 — A LEISURE CARE COMMUNITY —

SENIOR LIVING | MEMORY CARE
 CALL (757) 263-0011 OR VISIT
THEVEROATCHESAPEAKE.COM TO LEARN MORE.
 757 CEDAR ROAD, CHESAPEAKE, VA 23322

PLEASE PATRONIZE OUR ADVERTISERS... TO PLACE AN AD, CALL 1-800-292-9020

#892931-01-68023